

Since material handling and installation vary from country to country, the following information may not apply to the US, Canada, Mexico, and China. For these countries, please refer to the information provided by the local subsidiary of Nichiha.

**Detailed drawing of fitting status** Nichiha Siding Excelard 16 mm  
455 mm X 3,030 mm Horizontal clip installation



Clip installation



Vertical furring strips

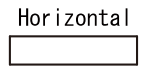

Horizontal

**Basic structure**

- Check the reinforced concrete exterior wall for any crack and repair it if necessary.
- Place the vertical studs with the interval of 500 mm or less as shown by the figure below.
- Add the vertical studs at an appropriate place so that accessories including clips on each part shall be secured.
- Perform the installation so that reference line misalignment and unevenness of mutual vertical studs shall be within 3 mm.

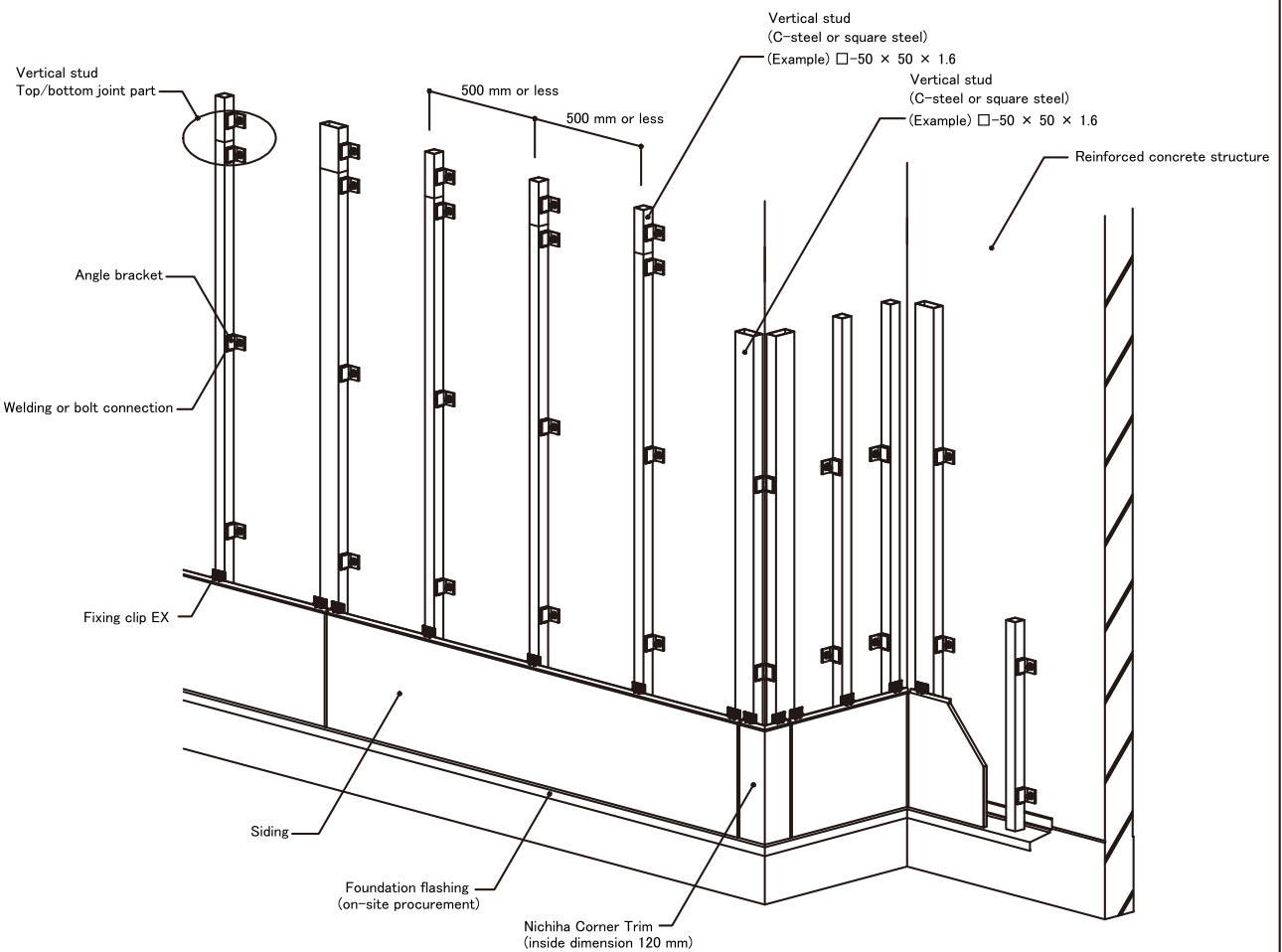

※ This fitting drawing is an example of installation method. Comply with laws and regulations, and implement the structure design allowing a sufficient safety factor.

Since material handling and installation vary from country to country, the following information may not apply to the US, Canada, Mexico, and China. For these countries, please refer to the information provided by the local subsidiary of Nichiha.

**Detailed drawing of fitting status** Nichiha Siding Excelard 16 mm  
455 mm X 3,030 mm Horizontal clip installation



Clip installation



Vertical furring strips

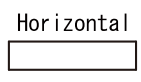

Horizontal

**Top/bottom joint**

- Caution shall be taken so that the fixing clip EX does not interfere with the joint part of the vertical stud (square pipe, etc.).

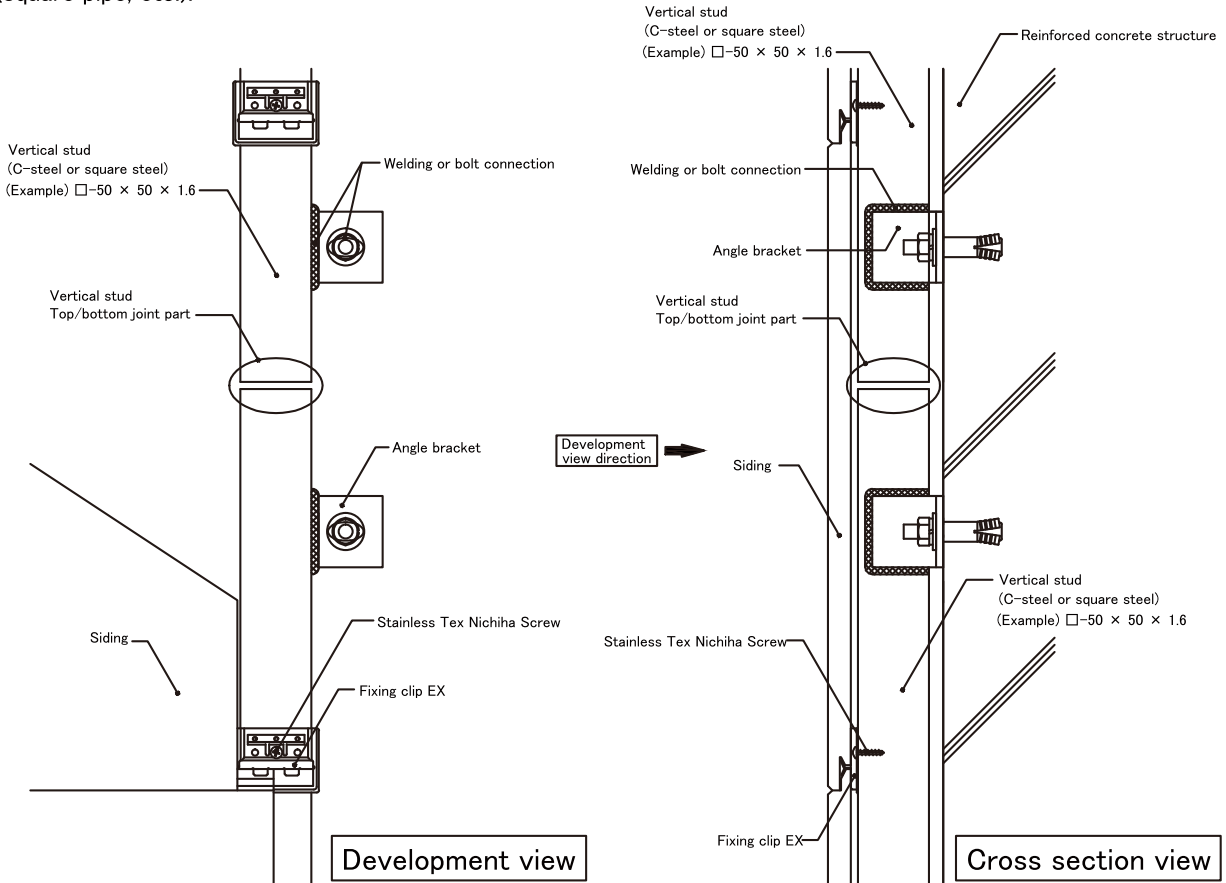

**Foundation**

- Fix the foundation flashing before installing the vertical studs.
- Keep 10 mm of space between the siding lower end and the flashing.

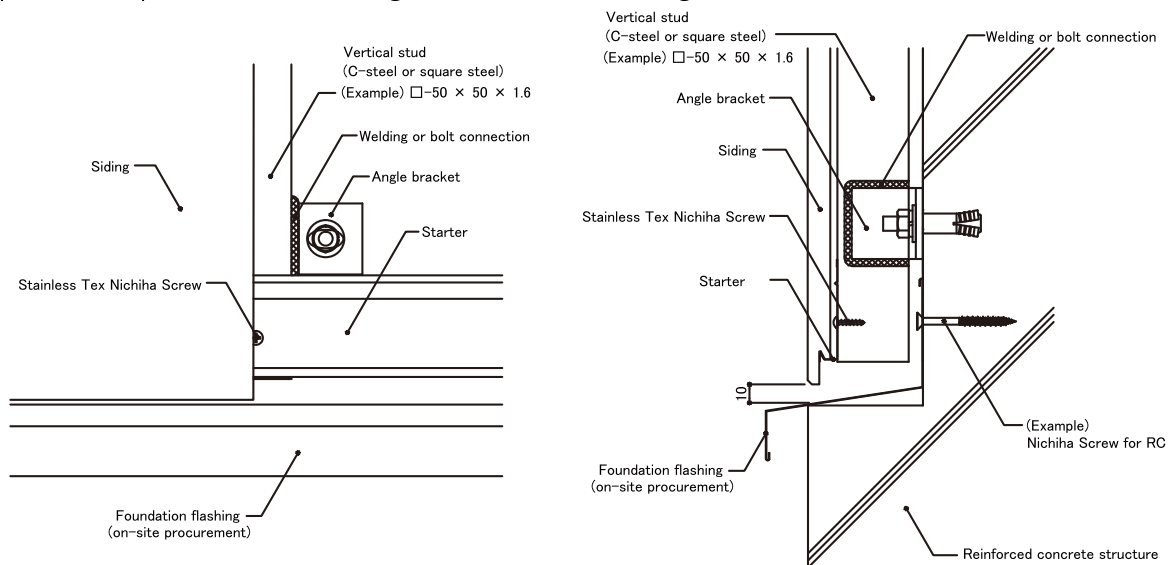

※ This fitting drawing is an example of installation method. Comply with laws and regulations, and implement the structure design allowing a sufficient safety factor.

Since material handling and installation vary from country to country, the following information may not apply to the US, Canada, Mexico, and China. For these countries, please refer to the information provided by the local subsidiary of Nichiha.

**Detailed drawing of fitting status** Nichiha Siding Excelard 16 mm  
455 mm X 3,030 mm Horizontal clip installation



Clip installation



Vertical furring strips

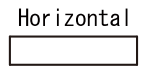

Horizontal

Right/left joint

● Be sure to install the structure to the right/left joints so that the clip EX can be secured.

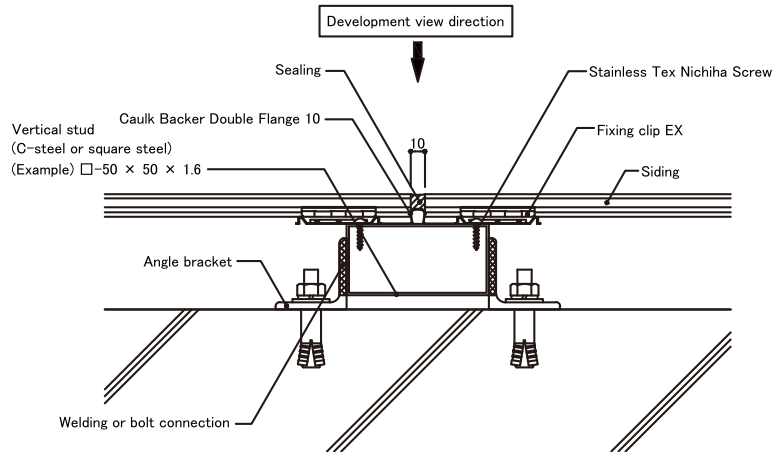

Plane view

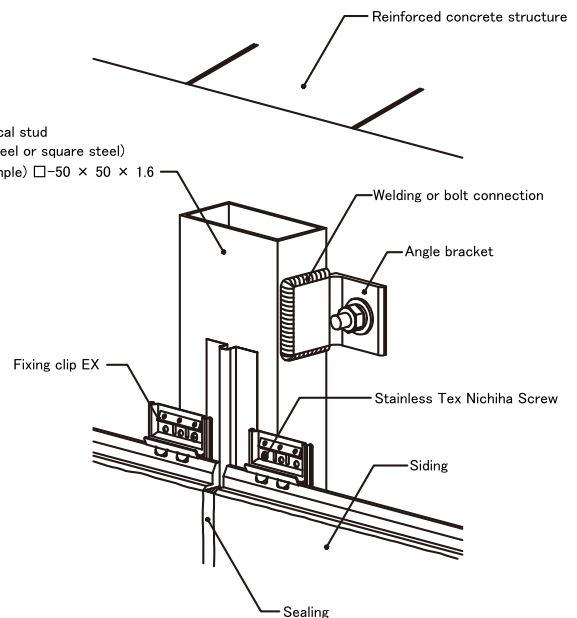
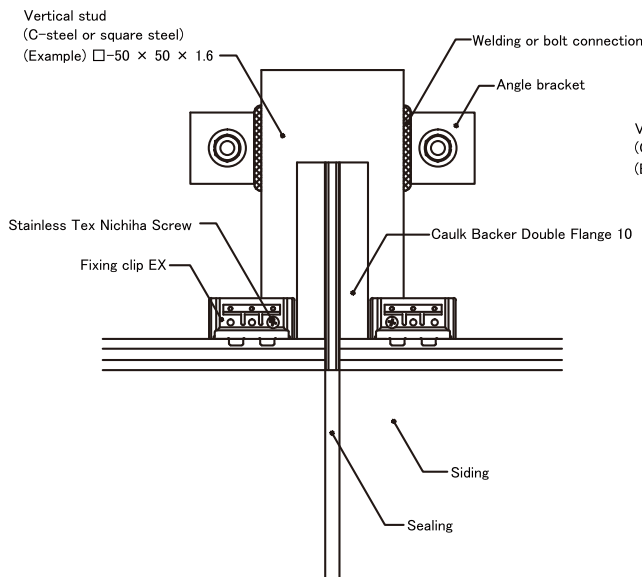

Development view

※ This fitting drawing is an example of installation method. Comply with laws and regulations, and implement the structure design allowing a sufficient safety factor.

Since material handling and installation vary from country to country, the following information may not apply to the US, Canada, Mexico, and China. For these countries, please refer to the information provided by the local subsidiary of Nichiha.

**Detailed drawing of fitting status** Nichiha Siding Excelard 16 mm  
455 mm X 3,030 mm Horizontal clip installation



Clip installation



Vertical furring strips

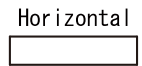

Horizontal

Outside corner

● Be sure to install the structure to the Nichiha Corner Trim joints so that the clip EX can be attached.

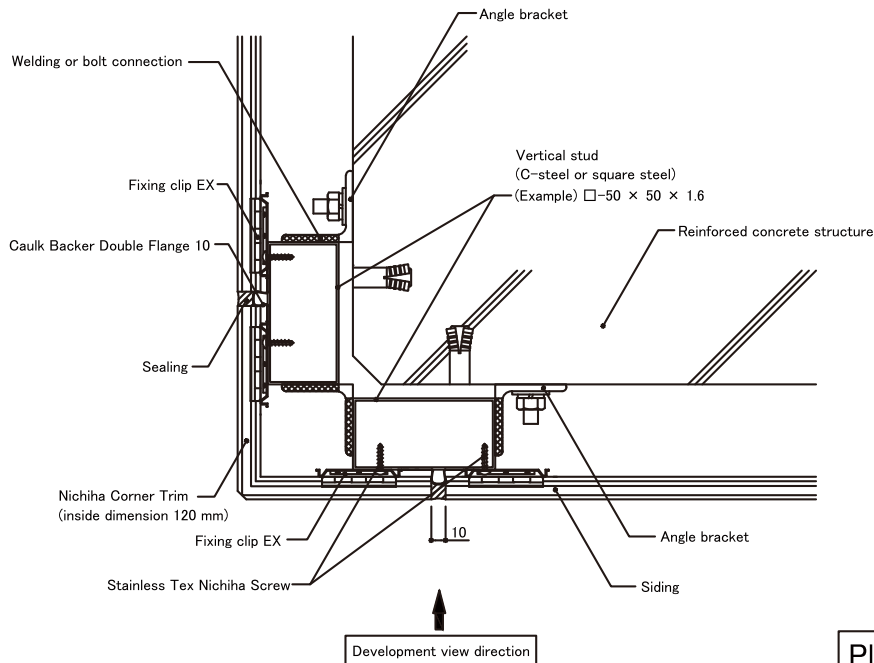

Plane view

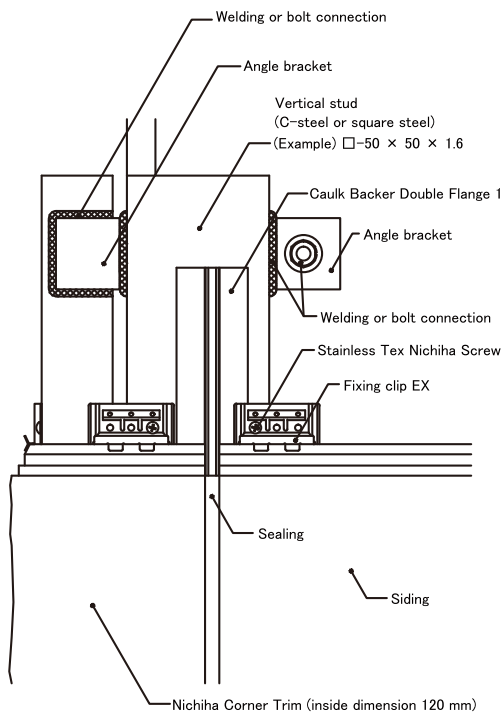

Development view

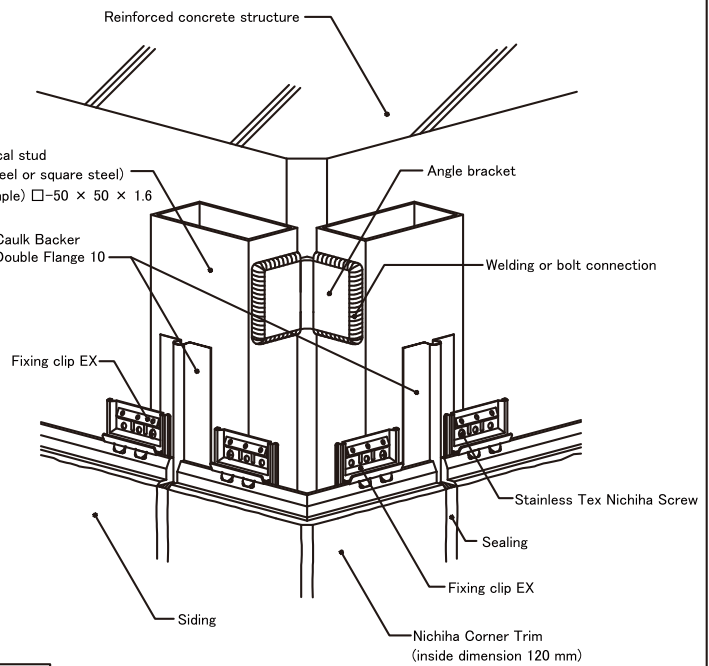

※ This fitting drawing is an example of installation method. Comply with laws and regulations, and implement the structure design allowing a sufficient safety factor.

Since material handling and installation vary from country to country, the following information may not apply to the US, Canada, Mexico, and China. For these countries, please refer to the information provided by the local subsidiary of Nichiha.

**Detailed drawing of fitting status** Nichiha Siding Excelard 16 mm  
455 mm X 3,030 mm Horizontal clip installation

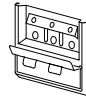

Clip installation

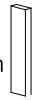

Vertical furring strips

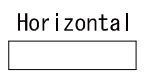

Horizontal

**Inside corner**

- Be sure to install the structure to the inside corner joints because the Caulk Backer Single Flange 17 is attached.
- For waterproof, be sure to install the Backup Inside Corner 50.

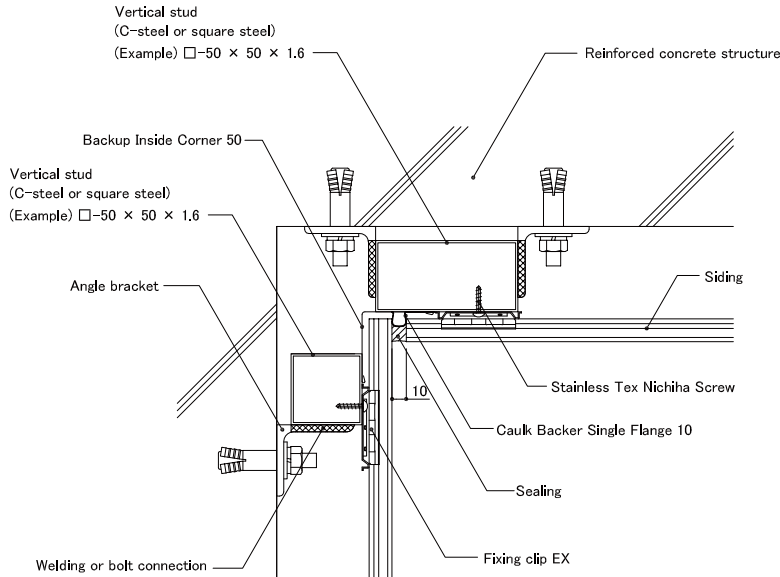

Plane view

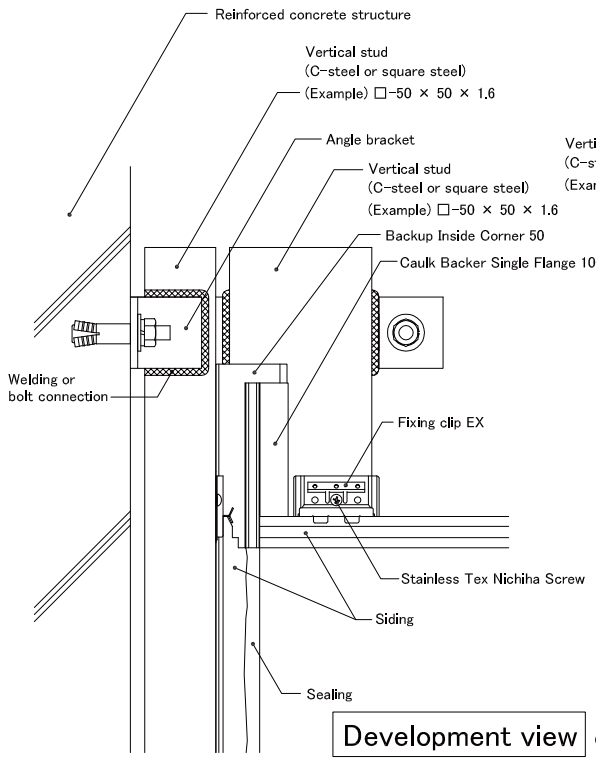

Development view

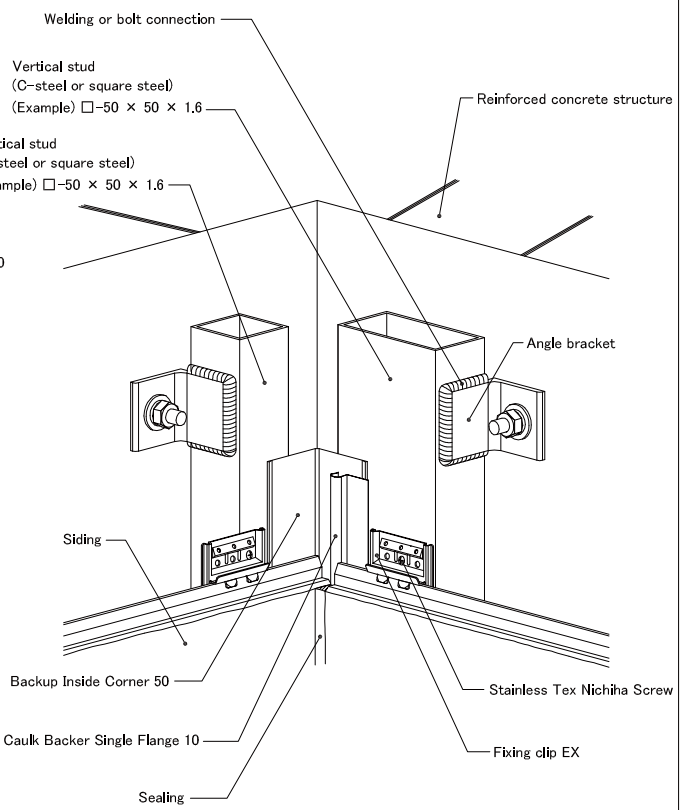

※ This fitting drawing is an example of installation method. Comply with laws and regulations, and implement the structure design allowing a sufficient safety factor.

Since material handling and installation vary from country to country, the following information may not apply to the US, Canada, Mexico, and China. For these countries, please refer to the information provided by the local subsidiary of Nichiha.

**Detailed drawing of fitting status** Nichiha Siding Excelard 16 mm  
455 mm X 3,030 mm Horizontal clip installation



Clip installation



Vertical furring strips

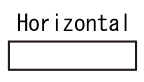

Horizontal

**Soffit (In case of paint finish)**

● For soffit parts, perform the installation with the J-Channel as shown by the figure below.

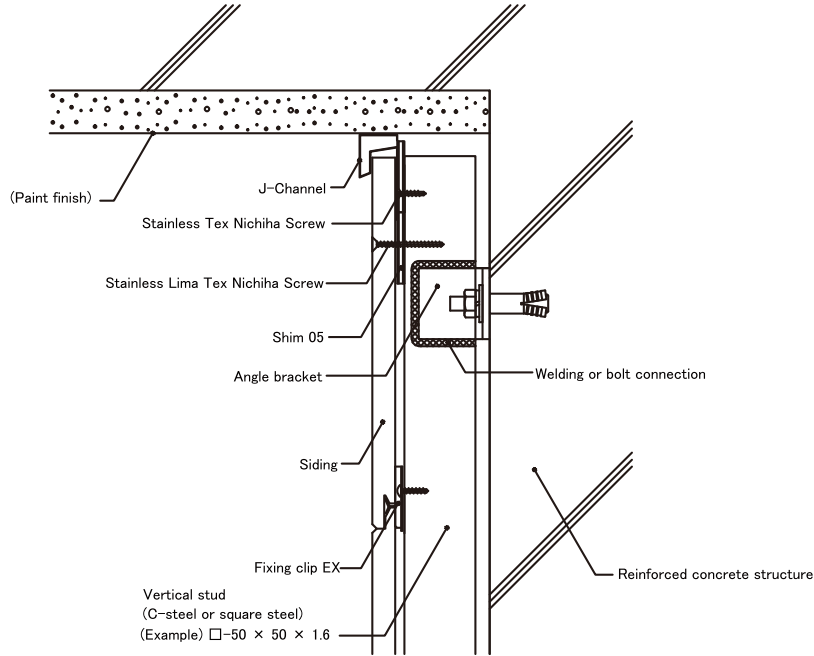

**Soffit (in case of soffit finish)**

● For soffit parts, perform the installation with the J-Channel as shown by the figure below.

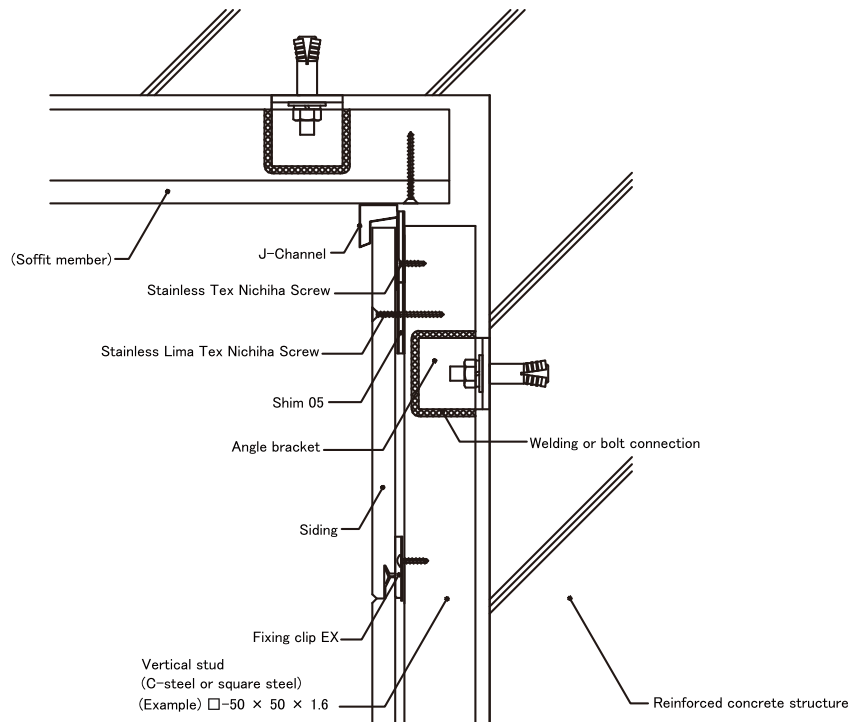

※ This fitting drawing is an example of installation method. Comply with laws and regulations, and implement the structure design allowing a sufficient safety factor.

Since material handling and installation vary from country to country, the following information may not apply to the US, Canada, Mexico, and China. For these countries, please refer to the information provided by the local subsidiary of Nichiha.

**Detailed drawing of fitting status** Nichiha Siding Excelard 16 mm  
455 mm X 3,030 mm Horizontal clip installation

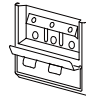

Clip installation

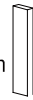

Vertical furring strips

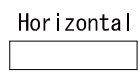

Horizontal

Openings top/bottom

● For areas around openings, procure the steel plate on site and perform the installation with the sealing joint of approx. 10 mm on the top and right/left sides. For bottom, procure the flashing on site and perform the installation as shown by the figure below.

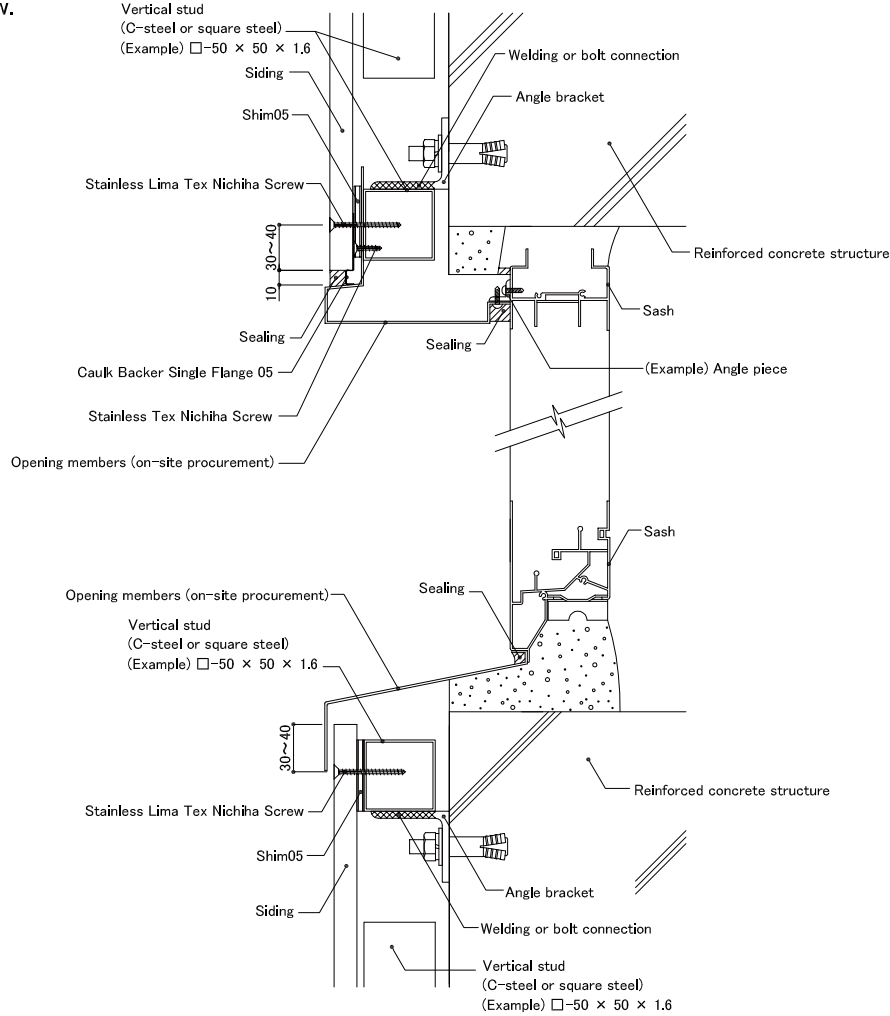

Openings right/left

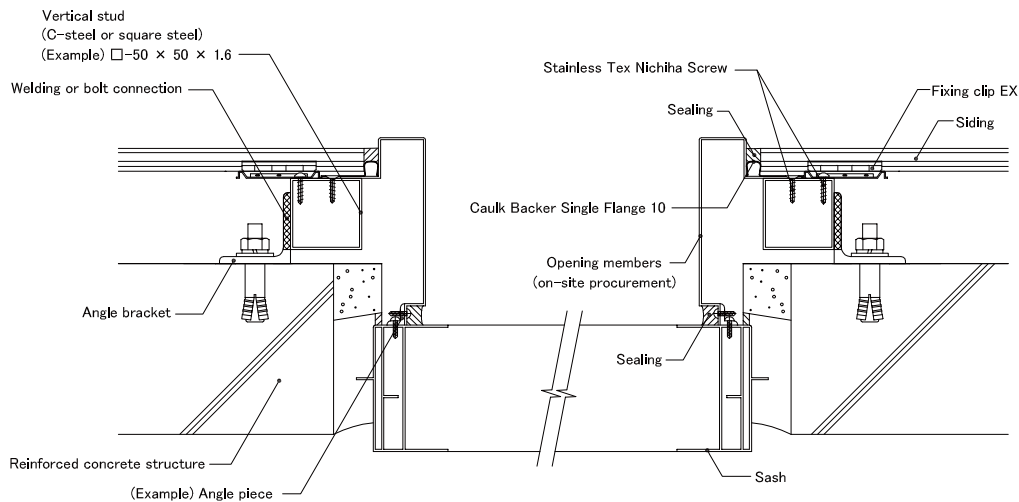

※ This fitting drawing is an example of installation method. Comply with laws and regulations, and implement the structure design allowing a sufficient safety factor.

Since material handling and installation vary from country to country, the following information may not apply to the US, Canada, Mexico, and China. For these countries, please refer to the information provided by the local subsidiary of Nichiha.

**Detailed drawing of fitting status** Nichiha Siding Excelard 16 mm  
455 mm X 3,030 mm Horizontal clip installation

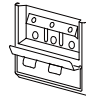

Clip installation

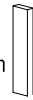

Vertical furring strips

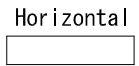

Horizontal

**Overhang part (steel plate member)**

- Secure the space of 10 mm or more between the overhang member (the on-site procurement is ok) and the siding lower end.

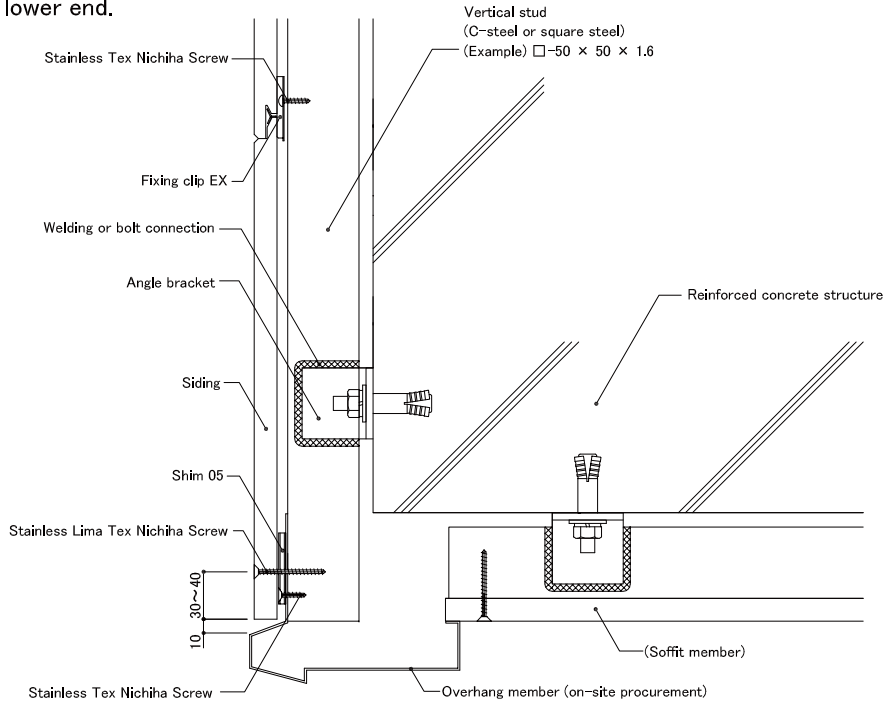

**Overhang (Nichiha Corner Trim)**

- When using the Nichiha Corner Trim for fitting, be sure to install the members for Nichiha Corner Trim (the on-site procurement is ok) to the inside.
- If the installation is performed without fitting, water accumulates on the backside of outside corners, causing the failure.

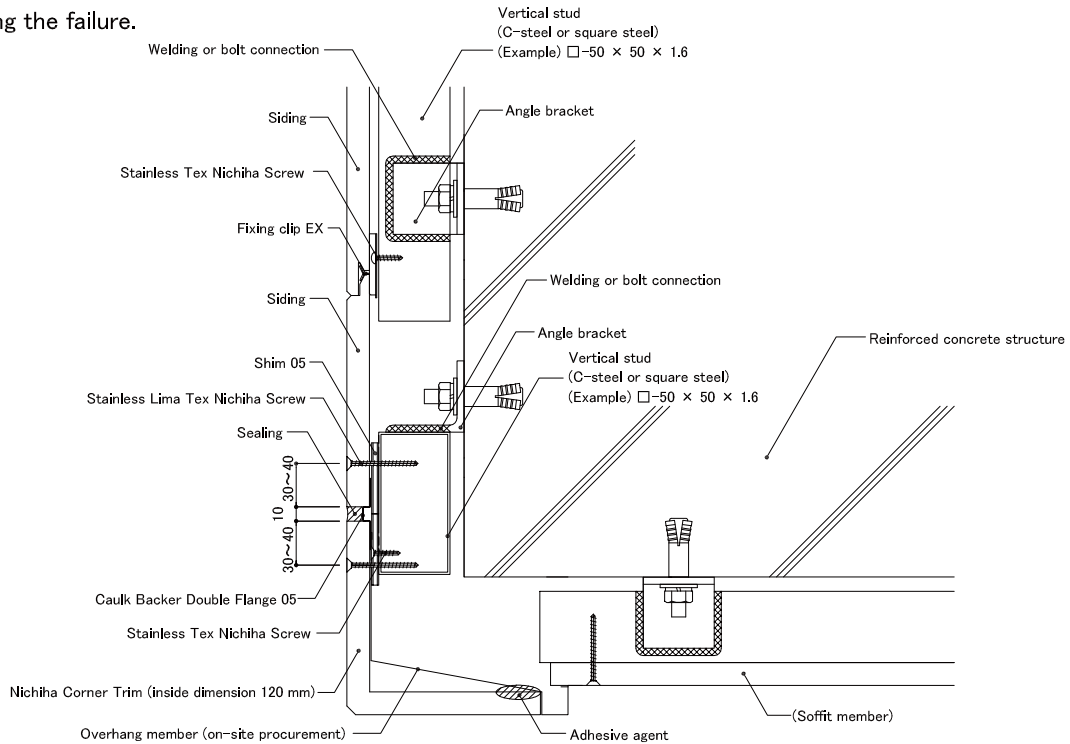

※ This fitting drawing is an example of installation method. Comply with laws and regulations, and implement the structure design allowing a sufficient safety factor.